

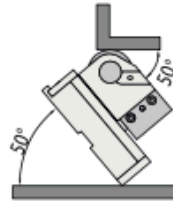

Çalışma Açısı / Work Angle

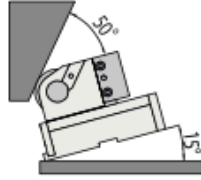

Kam Diyagramı / Cam Diagram

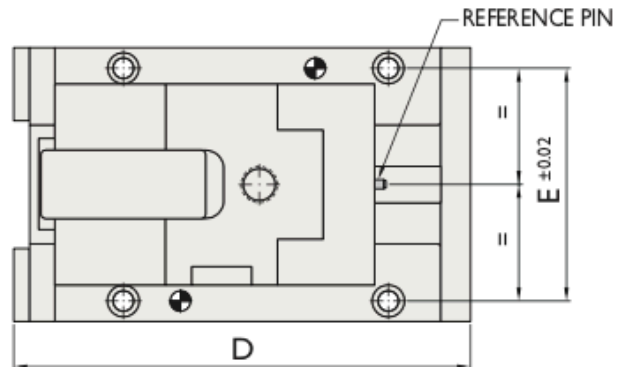
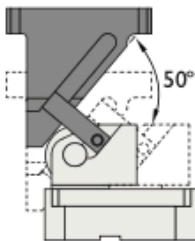
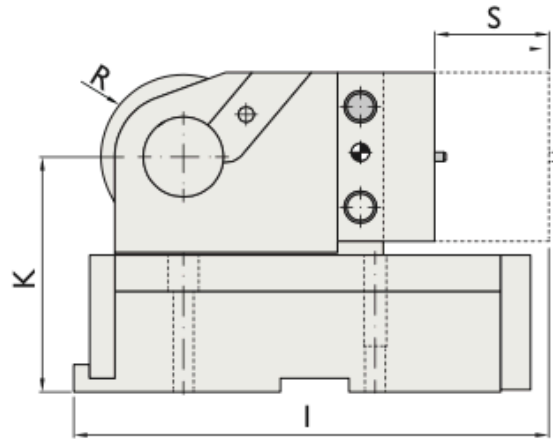
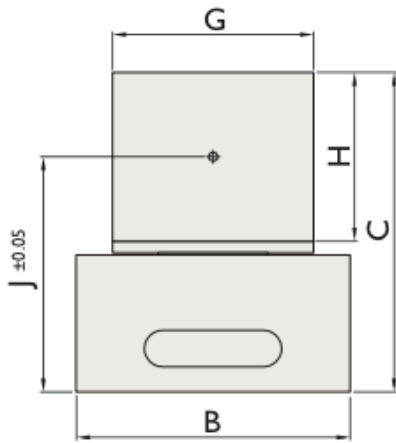
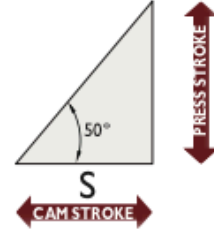

Kam Kodu Cam Kode	Kuvvet Force (daN)	Kurs Travel (S)	Ölçüler / Dimensions (mm)										kg
			G	H	B	C	D	E	I	J	K	R	
RK02	2000	22	50	50	75	85	115	63	103	63	63	23	3
RK02	2000	35	50	50	75	85	136	63	137	63	63	23	4
RK02	3000	50	68	63	100	117	200	82	208	86	86	31	11
RK02	3000	80	68	63	100	117	230	82	238	86	86	31	12
RK02	3000	100	68	63	100	117	260	82	258	86	110	31	17
RK02	5000	50	88	74	120	140	200	102	208	103	103	36	16
RK02	5000	80	88	74	120	140	230	102	238	103	103	36	17
RK02	5000	100	88	74	120	140	260	102	258	103	103	36	19
RK02	15000	50	132	92	170	165	220	150	216	120	120	45	29
RK02	15000	80	132	92	170	165	250	150	246	120	120	45	30
RK02	15000	100	132	92	170	165	270	150	266	120	120	45	32
RK02	20000	50	196	110	240	205	250	222	258	150	150	55	62
RK02	20000	80	196	110	240	205	280	222	288	150	150	55	64
RK02	20000	100	196	110	240	205	300	222	308	150	105	55	66

 Kod / Code	Kuvvet / Force daN	Kurs / Travel (S)
RK02	2000	22